

INSTRUÇÕES DE MONTAGEM
**APARADOR 4 PORTAS
COM PÉS METÁLICOS**

RIO

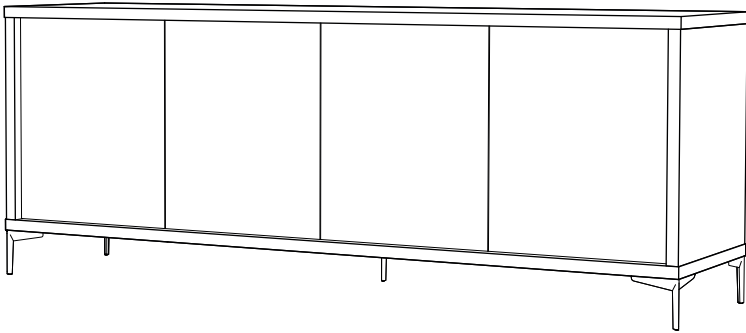

ANTARTE

design for life

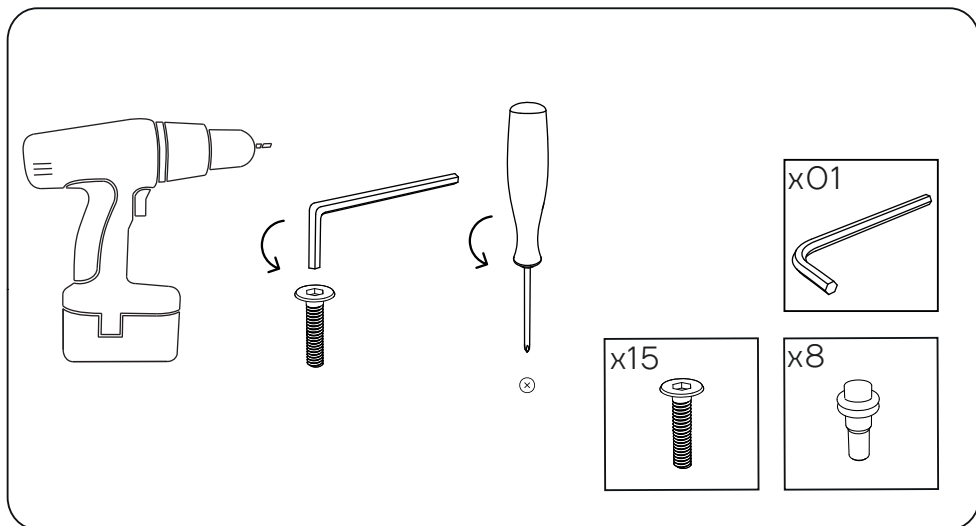

Obrigado pela sua preferência!

O design, a elegância e o conforto estão agora mais perto de si!



01

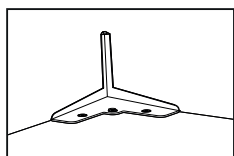
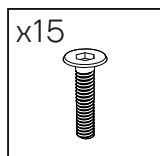
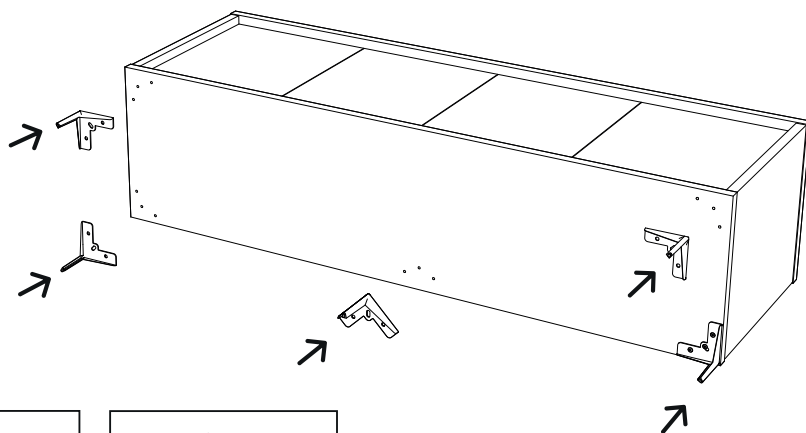

02

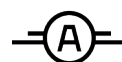
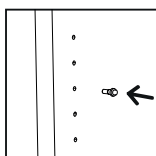
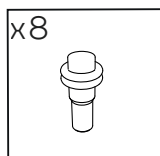
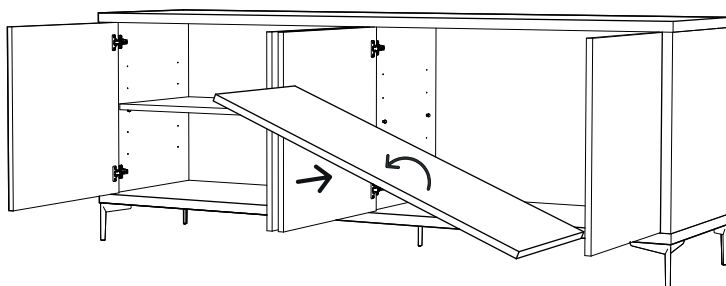

AFINAÇÃO DA PORTA

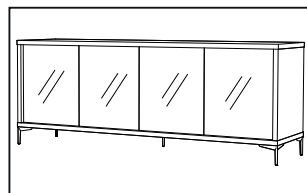
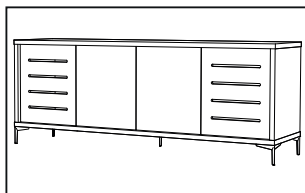
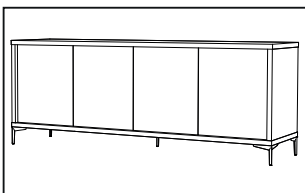
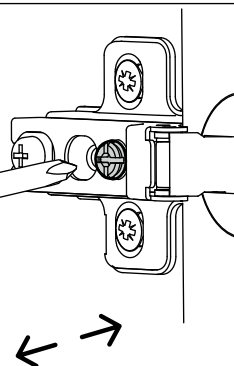
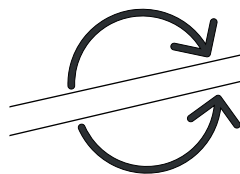
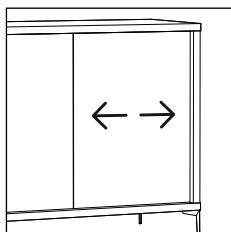
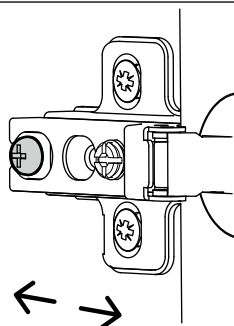
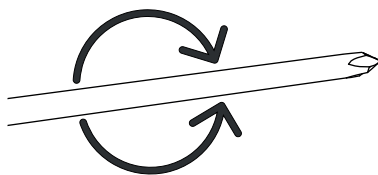
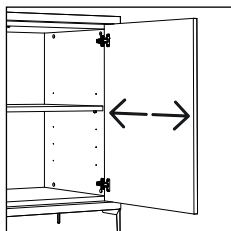

RIO Alaprador Liso / Frisos / Espelho 1950 | V1.2/2023



ANTARTE

design for life

SEDE:
AV. DA ZONA INDUSTRIAL, 222
4585-303 REBORDOSA
PAREDES, PORTUGAL
+351 224 119 350
(chamada para a rede fixa nacional)
ANTARTE@ANTARTE.PT
WWW.ANTARTE.PT