

INSTRUÇÕES DE MONTAGEM  
**APARADOR 3 PORTAS  
COM PÉS METÁLICOS**

RIO

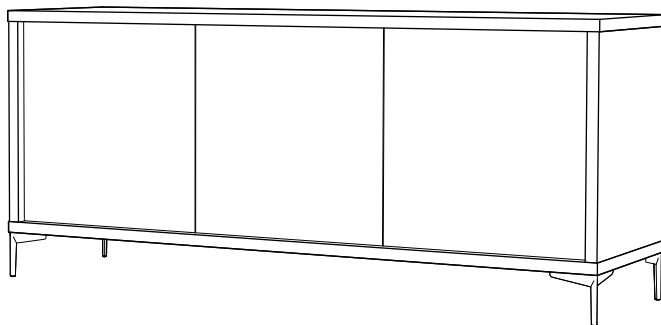

**ANTARTE**

design for life

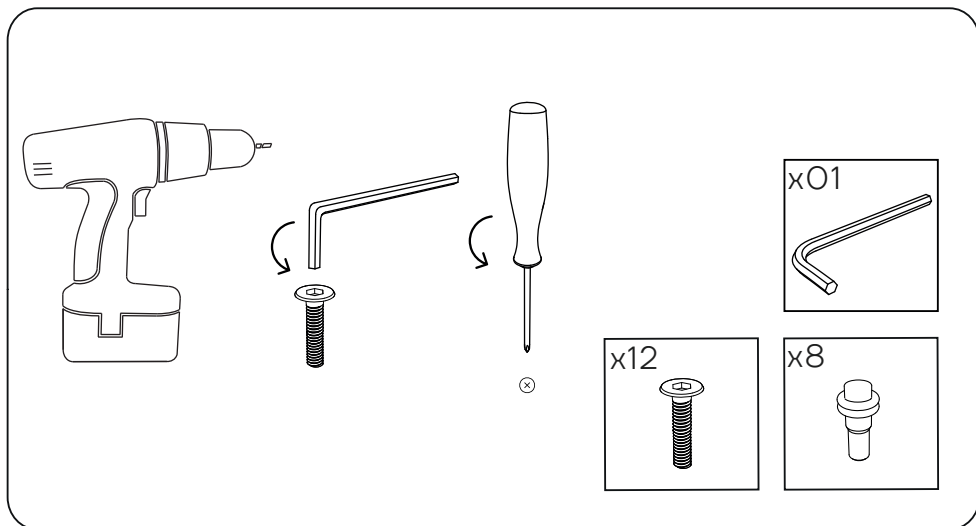

# Obrigado pela sua preferência!

O design, a elegância e o conforto  
estão agora mais perto de si!



01

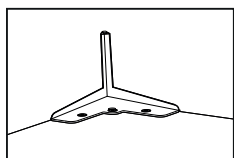
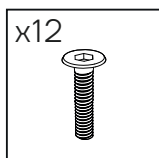
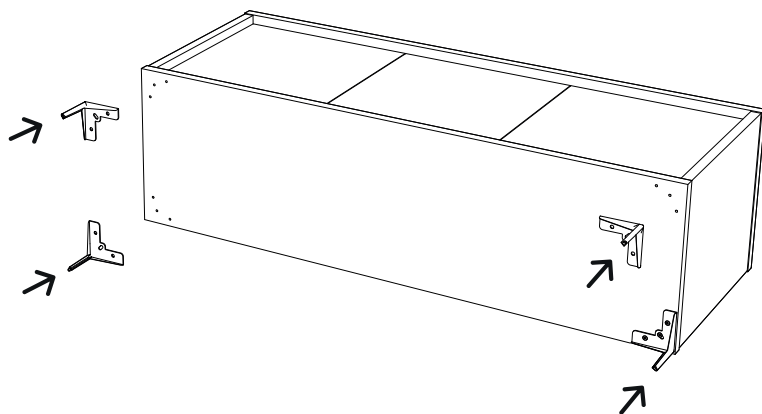

02

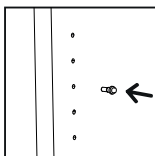
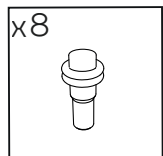
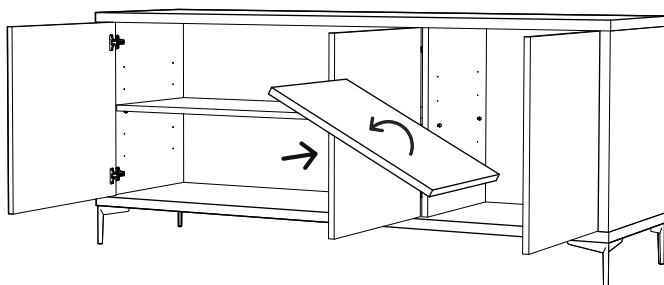

# AFINAÇÃO DA PORTA

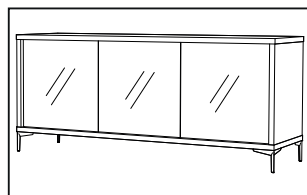
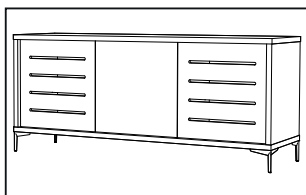
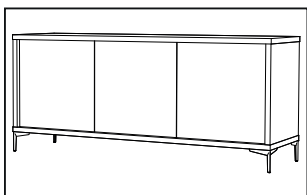
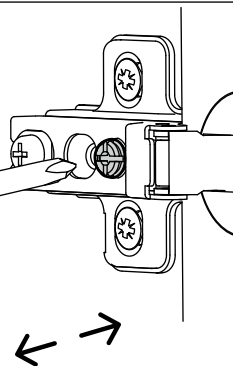
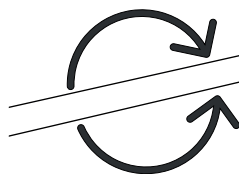
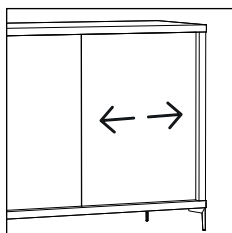
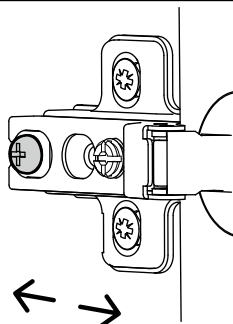
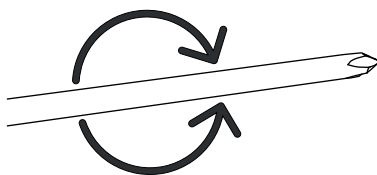
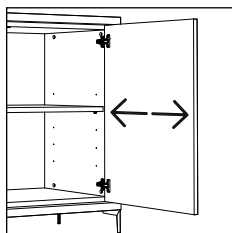

RIO Acorador, Liso / Frisos / Espelho T20 | V11/2/2023



## ANTARTE

design for life

SEDE:  
AV. DA ZONA INDUSTRIAL, 222  
4585-303 REBORDOSA  
PAREDES, PORTUGAL  
+351 224 119 350  
(chamada para a rede fixa nacional)  
ANTARTE@ANTARTE.PT  
[WWW.ANTARTE.PT](http://WWW.ANTARTE.PT)