

INSTRUÇÕES DE MONTAGEM
CAMISEIRO 4 GAVETAS
COM PÉS METÁLICOS

RIO

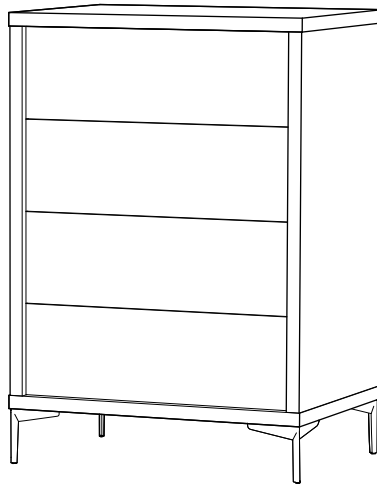

ANTARTE

design for life

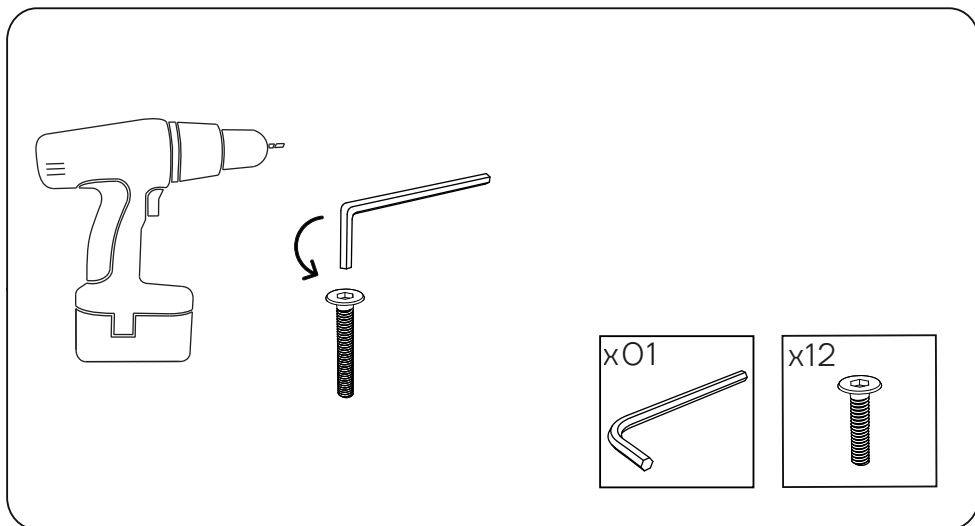

Obrigado pela sua preferência!

O design, a elegância e o conforto
estão agora mais perto de si!



01

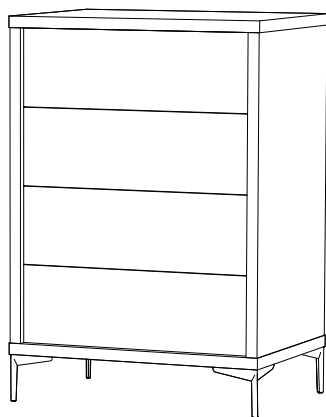
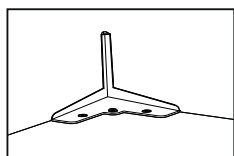
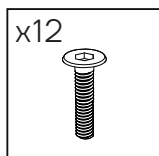
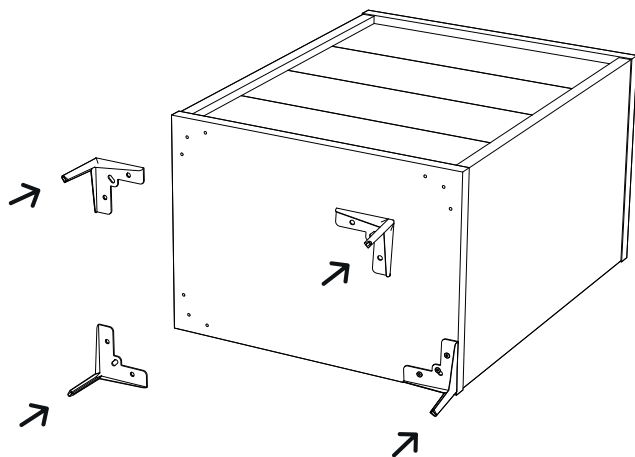

AFINAÇÃO DA GAVETA

CORREIÇA LADO ESQUERDO

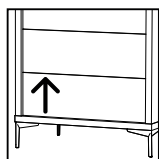
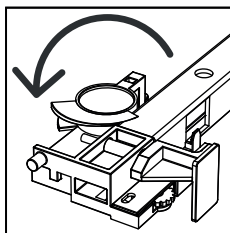
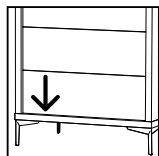
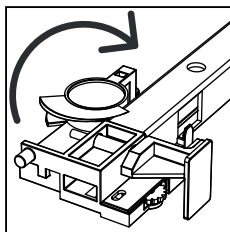

CORREIÇA LADO DIREITO

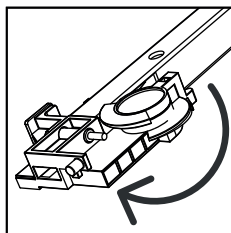
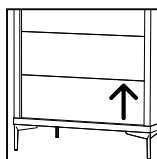
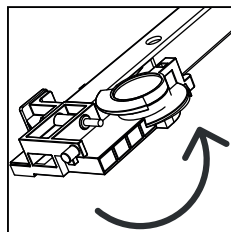
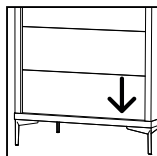

ANTARTE

design for life

SEDE:
AV. DA ZONA INDUSTRIAL, 222
4585-303 REBORDOSA
PAREDES, PORTUGAL
+351 224 119 350
(chamada para a rede fixa nacional)
ANTARTE@ANTARTE.PT
WWW.ANTARTE.PT