

INSTRUÇÕES DE MONTAGEM
CABECEIRA ALTA ESTOFADA
1500 / 1600 / 1700 / 1900

OPORTO

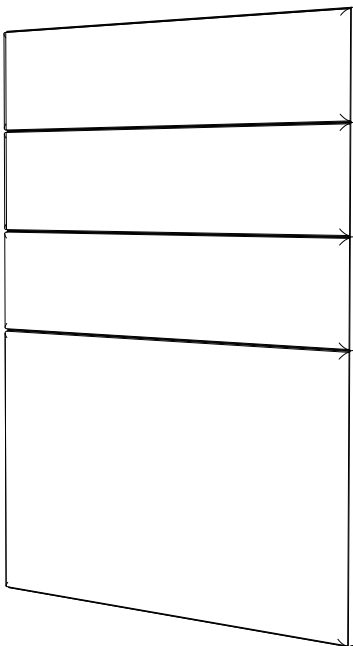

ANTARTE

design for life



Obrigado pela sua preferência!

O design, a elegância e o conforto
estão agora mais perto de si!



01

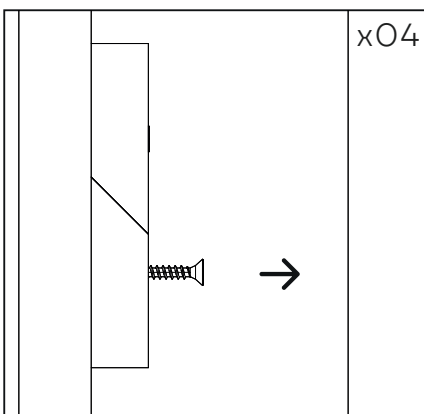
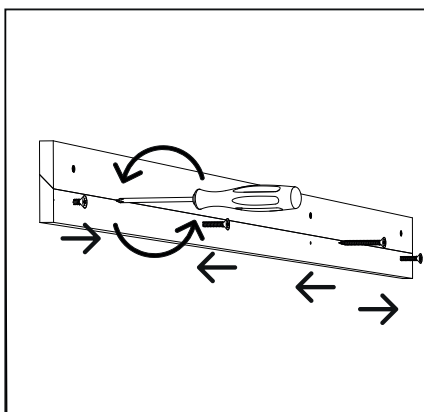
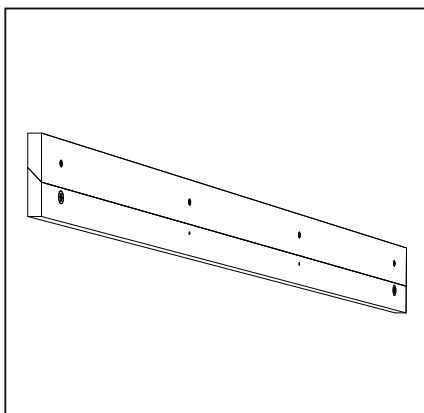

02

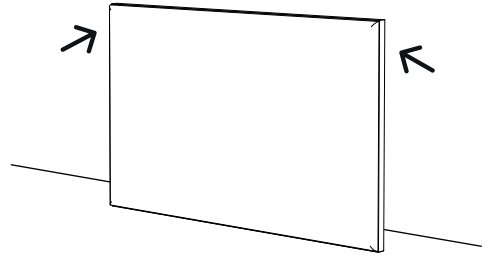
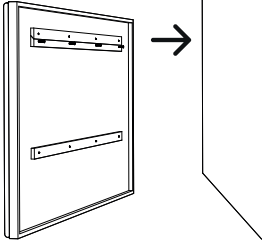

03

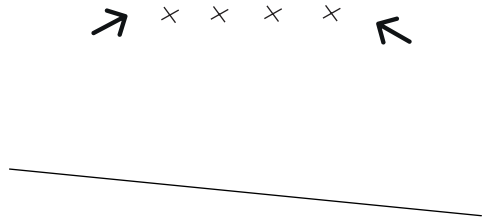
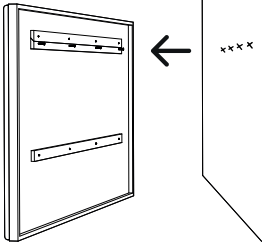

04

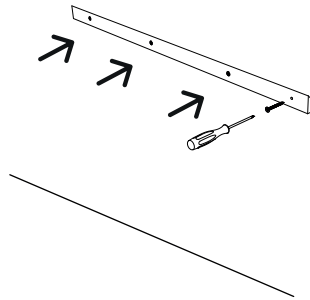
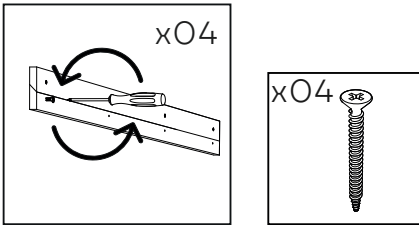

05

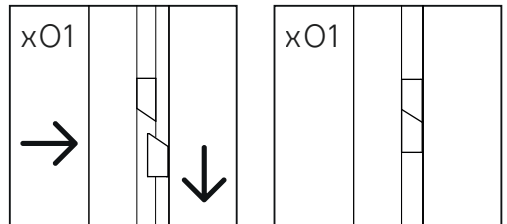
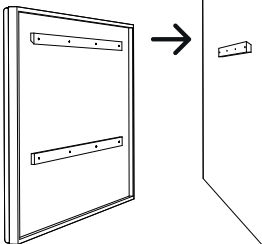

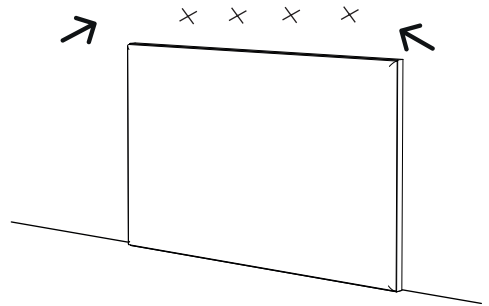
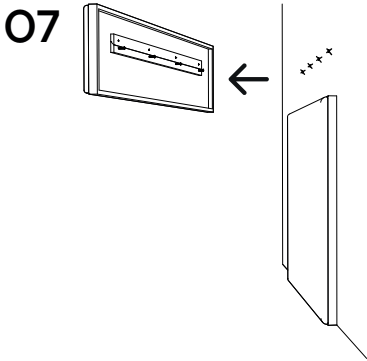
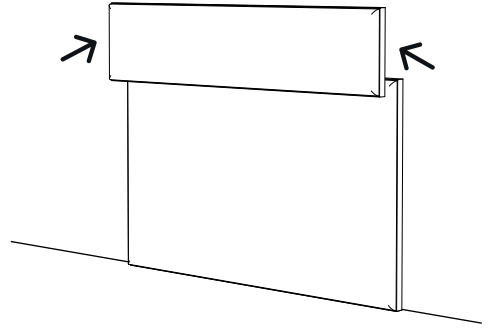
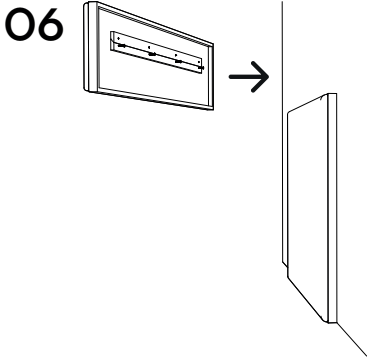

08

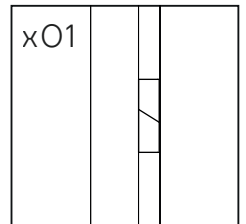
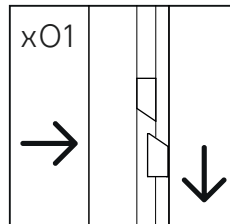
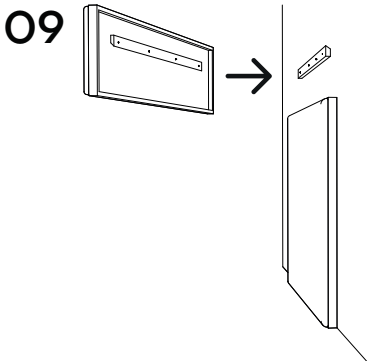
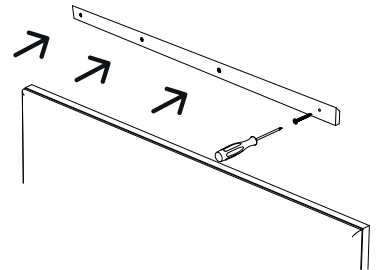
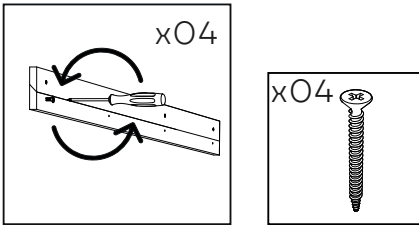

10

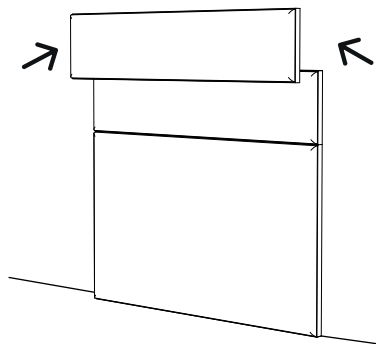
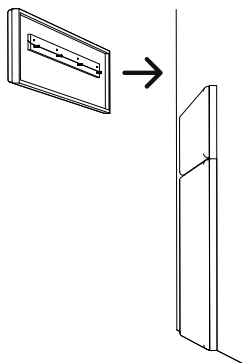

11

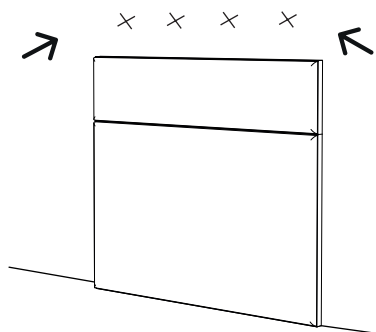
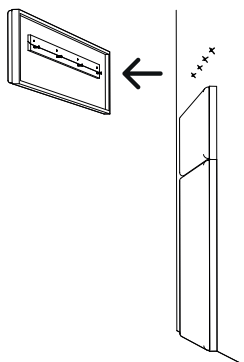

12

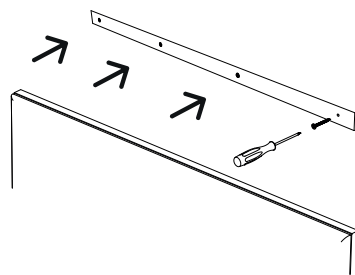
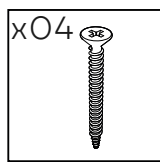
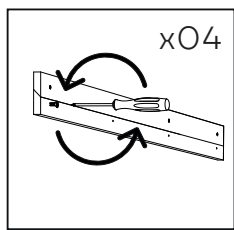

13

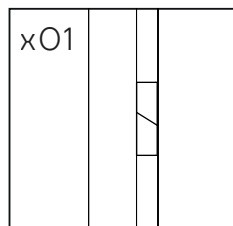
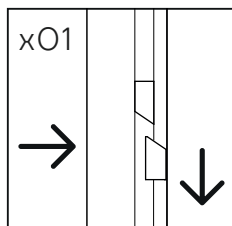
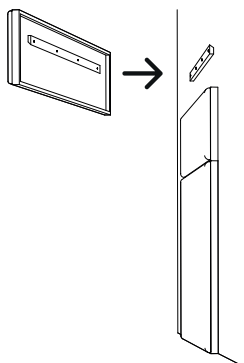

14

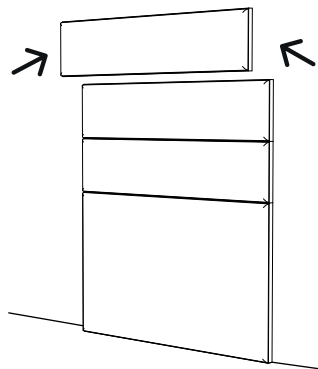
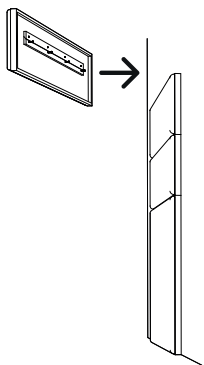

15

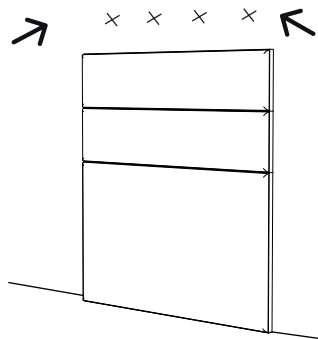
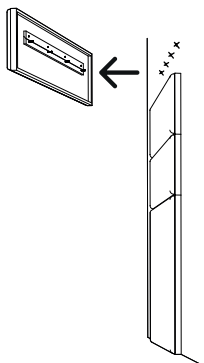

16

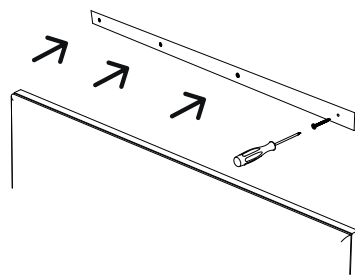
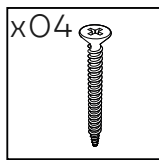
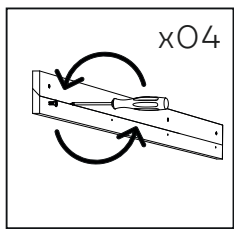

17

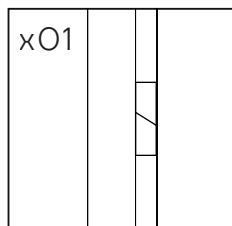
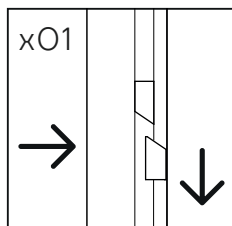
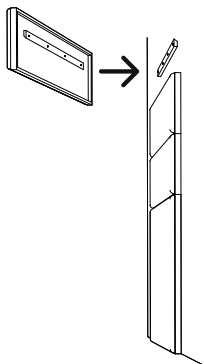



ANTARTE

design for life

SEDE:
AV. DA ZONA INDUSTRIAL, 222
4585-303 REBORDOSA
PAREDES, PORTUGAL
+351 224 119 350
(chamada para a rede fixa nacional)
ANTARTE@ANTARTE.PT
WWW.ANTARTE.PT